

**Description**

The DigiFlex® Performance™ (DP) Series digital servo drives are designed to drive brushed and brushless servomotors, stepper motors, and AC induction motors. These fully digital drives operate in torque, velocity, or position mode and employ Space Vector Modulation (SVM), which results in higher bus voltage utilization and reduced heat dissipation compared to traditional PWM. The drive can be configured for a variety of external command signals. Commands can also be configured using the drive's built-in Motion Engine, an internal motion controller used with distributed motion applications. In addition to motor control, these drives feature dedicated and programmable digital and analog inputs and outputs to enhance interfacing with external controllers and devices.

This DP Series drive features a CANopen interface for networking and a RS-232 interface for drive configuration and setup. Drive commissioning is accomplished using DriveWare® 7, available for download at [www.a-m-c.com](http://www.a-m-c.com).

All drive and motor parameters are stored in non-volatile memory. The DPC Series Hardware Installation Manual is available for download at [www.a-m-c.com](http://www.a-m-c.com).

Power Range	
Peak Current	60 A (42.4 A <sub>RMS</sub> )
Continuous Current	30 A (30 A <sub>RMS</sub> )
Supply Voltage	20 - 80 VDC



**Features**

- ▲ Follows the CAN in Automation (CiA) 301 Communications Profile and 402 Device Profile
- ▲ Four Quadrant Regenerative Operation
- ▲ Space Vector Modulation (SVM) Technology
- ▲ Fully Digital State-of-the-art Design
- ▲ Programmable Gain Settings
- ▲ Fully Configurable Current, Voltage, Velocity and Position Limits
- ▲ PIDF Velocity Loop
- ▲ PID + FF Position Loop
- ▲ Compact Size, High Power Density
- ▲ 16-bit Analog to Digital Hardware
- ▲ On-the-Fly Mode Switching
- ▲ On-the-Fly Gain Set Switching

**MODES OF OPERATION**

- Profile Modes
- Cyclic Synchronous Modes
- Current
- Velocity
- Position
- Interpolated Position Mode (PVT)

**COMMAND SOURCE**

- ±10 V Analog
- PWM and Direction
- Encoder Following
- Over the Network
- Sequencing
- Indexing
- Jogging

**FEEDBACK SUPPORTED**

- ±10 VDC Position
- Resolver
- Auxiliary Incremental Encoder
- Tachometer (±10 VDC)

**INPUTS/OUTPUTS**

- 3 High Speed Captures
- 3 Programmable Analog Inputs (16-bit/12-bit Resolution)
- 2 Programmable Analog Outputs (10-bit Resolution)
- 2 Programmable Digital Inputs (Differential)
- 6 Programmable Digital Inputs (Single-Ended)
- 4 Programmable Digital Outputs (Single-Ended)



**COMPLIANCES & AGENCY APPROVALS**

- UL
- cUL
- CE Class A (LVD)
- CE Class A (EMC)
- RoHS

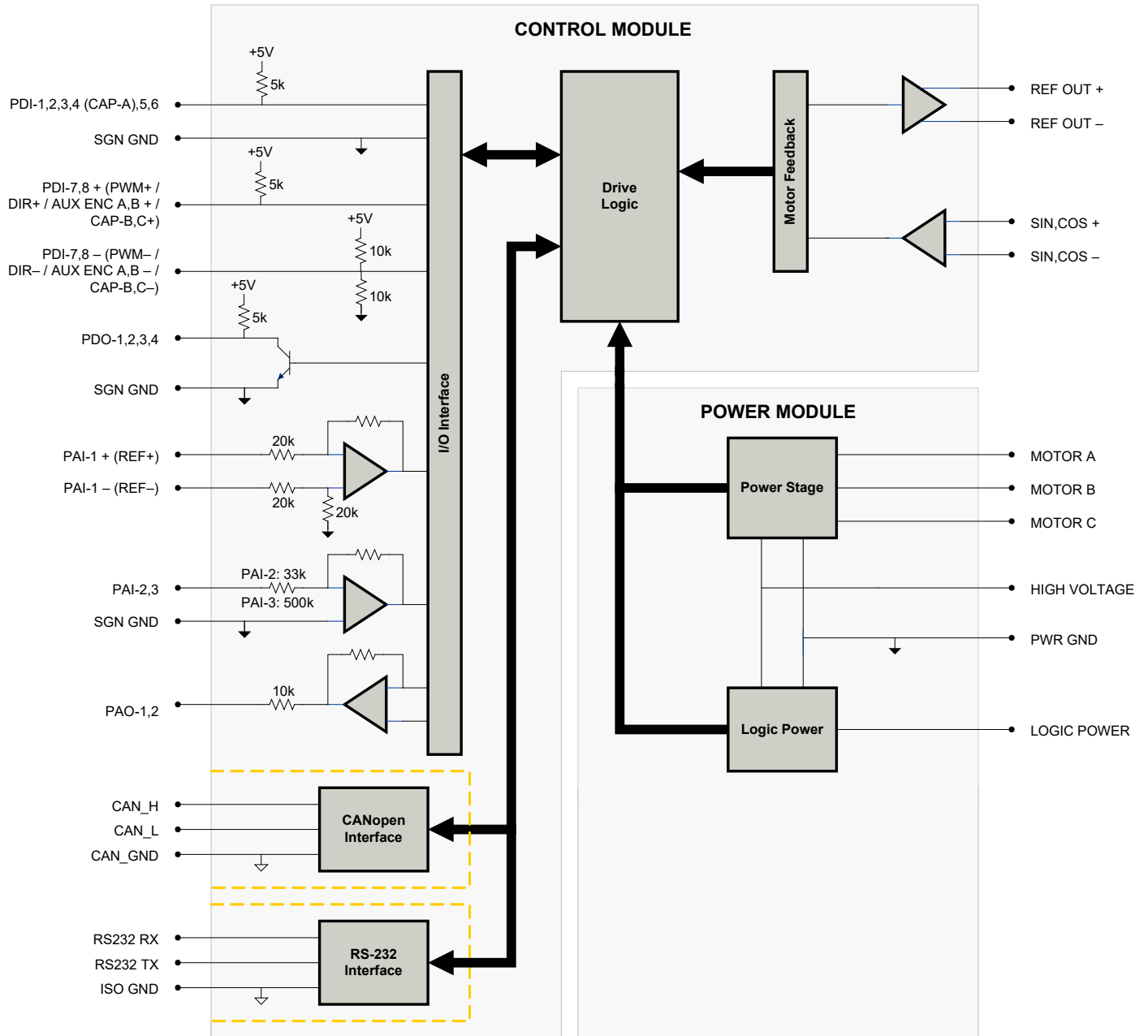
**BLOCK DIAGRAM**



**Information on Approvals and Compliances**

	<p>US and Canadian safety compliance with UL 508c, the industrial standard for power conversion electronics. UL registered under file number E140173. Note that machine components compliant with UL are considered UL registered as opposed to UL listed as would be the case for commercial products.</p>
	<p>Compliant with European EMC Directive 2014/30/EU on Electromagnetic Compatibility (specifically EN 61000-6-4:2007/A1:2011 for Emissions, Class A and EN 61000-6-2:2005 for Immunity, Performance Criteria A). LVD requirements of Directive 2014/35/EU (specifically, EN 60204-1:2006/A1:2009, a Low Voltage Directive to protect users from electrical shock).</p>
	<p>The RoHS Directive restricts the use of certain substances including lead, mercury, cadmium, hexavalent chromium and halogenated flame retardants PBB and PBDE in electronic equipment.</p>

**SPECIFICATIONS**

Power Specifications		
Description	Units	Value
DC Supply Voltage Range	VDC	20 - 80
DC Bus Over Voltage Limit	VDC	88.7
DC Bus Under Voltage Limit	VDC	17.5
Logic Supply Voltage	VDC	20 - 80
Maximum Peak Output Current <sup>1</sup>	A (Arms)	60 (42.4)
Maximum Continuous Output Current <sup>2</sup>	A (Arms)	30 (30)
Maximum Continuous Output Power	W	2280
Maximum Power Dissipation at Continuous Current	W	120
Internal Bus Capacitance	µF	500
Minimum Load Inductance (Line-To-Line) <sup>3</sup>	µH	250 (at 80 V supply); 150 (at 48 V supply); 75 (at 24 V supply)
Switching Frequency	kHz	20
Maximum Output PWM Duty Cycle	%	100
Low Voltage Supply Outputs	-	+5 VDC (250 mA)
Control Specifications		
Description	Units	Value
Communication Interfaces	-	CANopen (RS-232 for configuration)
Command Sources	-	±10 V Analog, Encoder Following, Over the Network, PWM and Direction, Sequencing, Indexing, Jogging
Feedback Supported	-	±10 VDC Position, Auxiliary Incremental Encoder, Resolver, Tachometer (±10 VDC)
Commutation Methods	-	Sinusoidal
Modes of Operation	-	Profile Modes, Cyclic Synchronous Modes, Current, Velocity, Position, Interpolated Position Mode (PVT)
Motors Supported <sup>4</sup>	-	Three Phase (Brushless Servo), Single Phase (Brushed Servo, Voice Coil, Inductive Load), Stepper (2- or 3-Phase Closed Loop), AC Induction (Closed Loop Vector)
Hardware Protection	-	40+ Configurable Functions, Over Current, Over Temperature (Drive & Motor), Over Voltage, Short Circuit (Phase-Phase & Phase-Ground), Under Voltage
Programmable Digital Inputs/Outputs (PDIs/PDOs)	-	8/4
Programmable Analog Inputs/Outputs (PAIs/PAOs)	-	3/2
Primary I/O Logic Level	-	5V TTL
Current Loop Sample Time	µs	50
Velocity Loop Sample Time	µs	100
Position Loop Sample Time	µs	100
Resolver Reference/Excitation Signal	Vrms	4 Vrms @ 5 kHz
Expected Resolver Transformation Ratio	Vrms	0.5
Feedback Resolution / Emulated Encoder Resolution <sup>5</sup>	bit	High Res: 14 (16384 counts/resolver cycle), Low Res: 12 (4096 counts/resolver cycle)
Maximum Motor Speed Per Feedback Resolution	RPM	High Res: 5000, Low Res: 20000
Mechanical Specifications		
Description	Units	Value
Agency Approvals	-	CE Class A (EMC), CE Class A (LVD), cUL, RoHS, UL
Size (H x W x D)	mm (in)	190.5 x 111.8 x 35.9 (7.5 x 4.4 x 1.4)
Weight	g (oz)	872 (30.8)
Heatsink (Base) Temperature Range <sup>6</sup>	°C (°F)	0 - 75 (32 - 167)
Storage Temperature Range	°C (°F)	-40 - 85 (-40 - 185)
Form Factor	-	Panel Mount
Cooling System	-	Natural Convection
IP Rating	-	IP10
AUX COMM Connector	-	3-pin, 2.5 mm spaced, enclosed, friction lock header
COMM Connector	-	Shielded, dual RJ-45 socket with LEDs
FEEDBACK Connector	-	15-pin, high-density, female D-sub
I/O Connector	-	26-pin, high-density, female D-sub
MOTOR POWER Connector	-	3-port, 7.62 mm spaced, enclosed, friction lock header
POWER Connector	-	4-port, 7.62 mm spaced, enclosed, friction lock header

**Notes**

1. Capable of supplying drive rated peak current for 2 seconds with 10 second foldback to continuous value. Longer times are possible with lower current limits.
2. Continuous  $A_{rms}$  value attainable when RMS Charge-Based Limiting is used.
3. Lower inductance is acceptable for bus voltages well below maximum. Use external inductance to meet requirements.
4. Maximum motor speed for stepper motors is 600 RPM. Consult the hardware installation manual for 2-phase stepper wiring configuration.
5. Higher and lower resolution options are available. Contact Applications Engineering for more information.
6. Additional cooling and/or heatsink may be required to achieve rated performance.

**PIN FUNCTIONS**

<b>AUX COMM - RS232 Communication Connector</b>			
Pin	Name	Description / Notes	I/O
1	RS232 RX	Receive Line (RS-232)	I
2	RS232 TX	Transmit Line (RS-232)	O
3	ISO GND	Isolated Signal Ground	IGND

<b>COMM - CAN Communication Connector</b>			
Pin	Name	Description / Notes	I/O
1	CAN_H	CAN_H Line (Dominant High)	I
2	CAN_L	CAN_L Line (Dominant Low)	I
3	CAN_GND	CAN Ground	CGND
4	RESERVED	Reserved	-
5	RESERVED	Reserved	-
6	RESERVED	Reserved	-
7	CAN_GND	CAN Ground	CGND
8	RESERVED	Reserved	-

<b>FEEDBACK - Feedback Connector</b>			
Pin	Name	Description / Notes	I/O
1	RESERVED	Reserved	-
2	RESERVED	Reserved	-
3	RESERVED	Reserved	-
4	REF OUT +	Resolver Reference/Excitation Output (50 mA maximum)	O
5	REF OUT -		O
6	SIN+	Resolver Sine Input	I
7	SIN-		I
8	COS+		Resolver Cosine Input
9	COS-	I	
10	RESERVED	Reserved	-
11	RESERVED	Reserved	-
12	SGN GND	Signal Ground	SGND
13	+5V OUT	+5V Encoder Supply Output (Short Circuit Protected)	O
14	PAI-3	Programmable Analog Input (12-bit Resolution)	I
15	RESERVED	Reserved	-

<b>I/O - Signal Connector</b>			
Pin	Name	Description / Notes	I/O
1	PDO-1	Programmable Digital Output	O
2	SGN GND	Signal Ground	SGND
3	PDO-2	Programmable Digital Output	O
4	PAI-1 + (REF+)	Differential Programmable Analog Input or Reference Signal Input (16-bit Resolution)	I
5	PAI-1 - (REF-)		I
6	PAI-2	Programmable Analog Input (12-bit Resolution)	I
7	PAO-1	Programmable Analog Output (10-bit Resolution)	O
8	PAO-2	Programmable Analog Output (10-bit Resolution)	O
9	PDI-8 - (DIR- / AUX ENC B- / CAP-C-)	Programmable Digital Input or Direction or Auxiliary Encoder or High Speed Capture (Leave Open for Single-Ended Signal)	I
10	PDO-3	Programmable Digital Output	O
11	PDI-1	Programmable Digital Input	I
12	PDI-2	Programmable Digital Input	I
13	PDI-3	Programmable Digital Input	I
14	PDO-4	Programmable Digital Output	O
15	+5V OUT	+5V Encoder Supply Output (Short Circuit Protected)	O
16	SGN GND	Signal Ground	SGND
17	PDI-7 + (PWM + / AUX ENC A+ / CAP-B+)	Programmable Digital Input or PWM or Auxiliary Encoder or High Speed Capture	I
18	PDI-8 + (DIR+ / AUX ENC B+ / CAP-C+)	Programmable Digital Input or Direction or Auxiliary Encoder or High Speed Capture	I
19	PDI-4 (CAP-A)	Programmable Digital Input or High Speed Capture	I
20	PDI-5	Programmable Digital Input	I
21	PDI-6	Programmable Digital Input	I
22	SGN GND	Signal Ground	SGND
23	RESERVED	Reserved	-
24	RESERVED	Reserved	-
25	RESERVED	Reserved	-
26	PDI-7 - (PWM- / AUX ENC A- / CAP-B-)	Programmable Digital Input or PWM or Auxiliary Encoder or High Speed Capture (Leave Open for Single-Ended Signals)	I

<b>MOTOR POWER - Power Connector</b>			
Pin	Name	Description / Notes	I/O
1	MOTOR A	Motor Phase A	O
2	MOTOR B	Motor Phase B	O
3	MOTOR C	Motor Phase C	O

<b>POWER - Power Connector</b>			
Pin	Name	Description / Notes	I/O
1	PWR GND	Power Ground (Common With Signal Ground)	PGND
2	HIGH VOLTAGE	DC Power Input	I
3	LOGIC GND	Logic Supply Ground (Common With Signal Ground)	GND
4	LOGIC PWR	Logic Supply Input	I

**HARDWARE SETTINGS**

**Switch Functions**

Switch	Description	Setting	
		On	Off
1	Bit 0 of binary CANopen node ID. Does not affect RS-232 settings.	1	0
2	Bit 1 of binary CANopen node ID. Does not affect RS-232 settings.	1	0
3	Bit 2 of binary CANopen node ID. Does not affect RS-232 settings.	1	0
4	Bit 3 of binary CANopen node ID. Does not affect RS-232 settings.	1	0
5	Bit 4 of binary CANopen node ID. Does not affect RS-232 settings.	1	0
6	Bit 5 of binary CANopen node ID. Does not affect RS-232 settings.	1	0
7	Bit 0 of drive CANopen bit rate setting. Does not affect RS-232 settings.	1	0
8	Bit 1 of drive CANopen bit rate setting. Does not affect RS-232 settings.	1	0

*Additional Details*

The drive can be configured to use the address and/or bit rate stored in non-volatile memory by setting the address and/or bit rate value to 0. Use the table below to map actual bit rates to a bit rate setting. Note that higher bit rates are possible when using the value stored in NVM.

Bit Rate (kbits/sec)	Value For Bit Rate Setting
Load from non-volatile memory	0
500	1
250	2
125	3

**CAN Termination Jumper Configuration**

Jumper	Description	Configuration			
		Header Jumper	Not Installed	Pins 1-2	Pins 3-4
J1	CAN bus termination. For the last drive in a CAN network, a jumper (2.54mm) must be installed on the 4-pin header adjacent to the RS-232 connector. The jumper should be installed between pins 1 and 2, which are the two pins furthest from the connector (see graphic below).		Non-terminating Node	Terminating Node	N/A

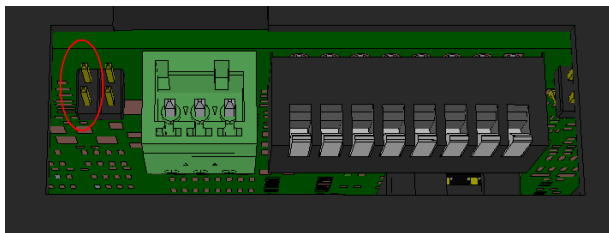

**MECHANICAL INFORMATION**

**AUX COMM - RS232 Communication Connector**

Connector Information	3-pin, 2.5 mm spaced, enclosed, friction lock header	
Mating Connector	Details	Phoenix: Plug P/N 1881338
	Included with Drive	Yes

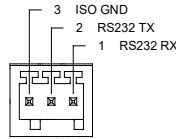

**COMM - CAN Communication Connector**

Connector Information	Shielded, dual RJ-45 socket with LEDs	
Mating Connector	Details	AMP: Plug P/N 5-569552-3
	Included with Drive	No

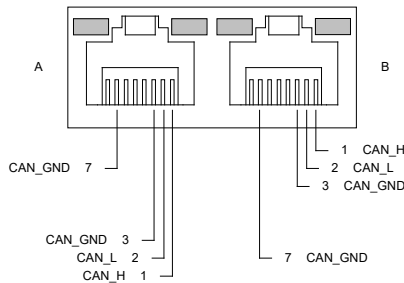

**FEEDBACK - Feedback Connector**

Connector Information	15-pin, high-density, female D-sub	
Mating Connector	Details	TYCO: Plug P/N 748364-1; Housing P/N 5748677-1; Terminals P/N 1658670-2 (loose) or 1658670-1 (strip)
	Included with Drive	No

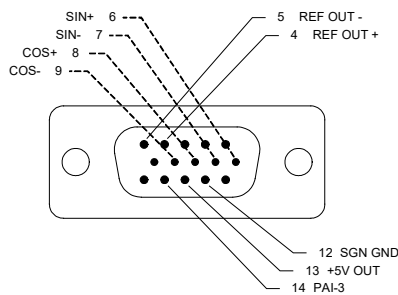

**I/O - Signal Connector**

Connector Information		26-pin, high-density, female D-sub
Mating Connector	Details	TYCO: Plug P/N 1658671-1; Housing P/N 5748677-2; Terminals P/N 1658670-2 (loose) or 1658670-1 (strip)
	Included with Drive	No

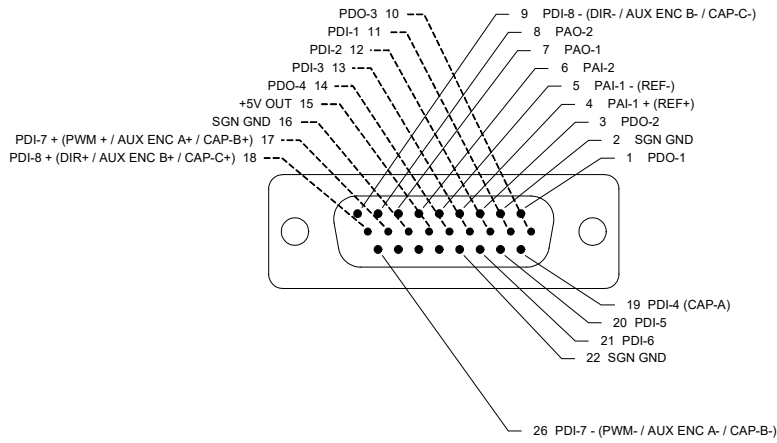

**MOTOR POWER - Power Connector**

Connector Information		3-port, 7.62 mm spaced, enclosed, friction lock header
Mating Connector	Details	Phoenix Contact: P/N 1804917
	Included with Drive	Yes

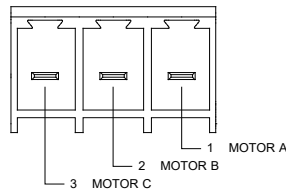

**POWER - Power Connector**

Connector Information		4-port, 7.62 mm spaced, enclosed, friction lock header
Mating Connector	Details	Phoenix Contact: P/N 1804920
	Included with Drive	Yes

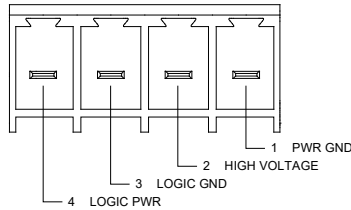



**MOUNTING DIMENSIONS**

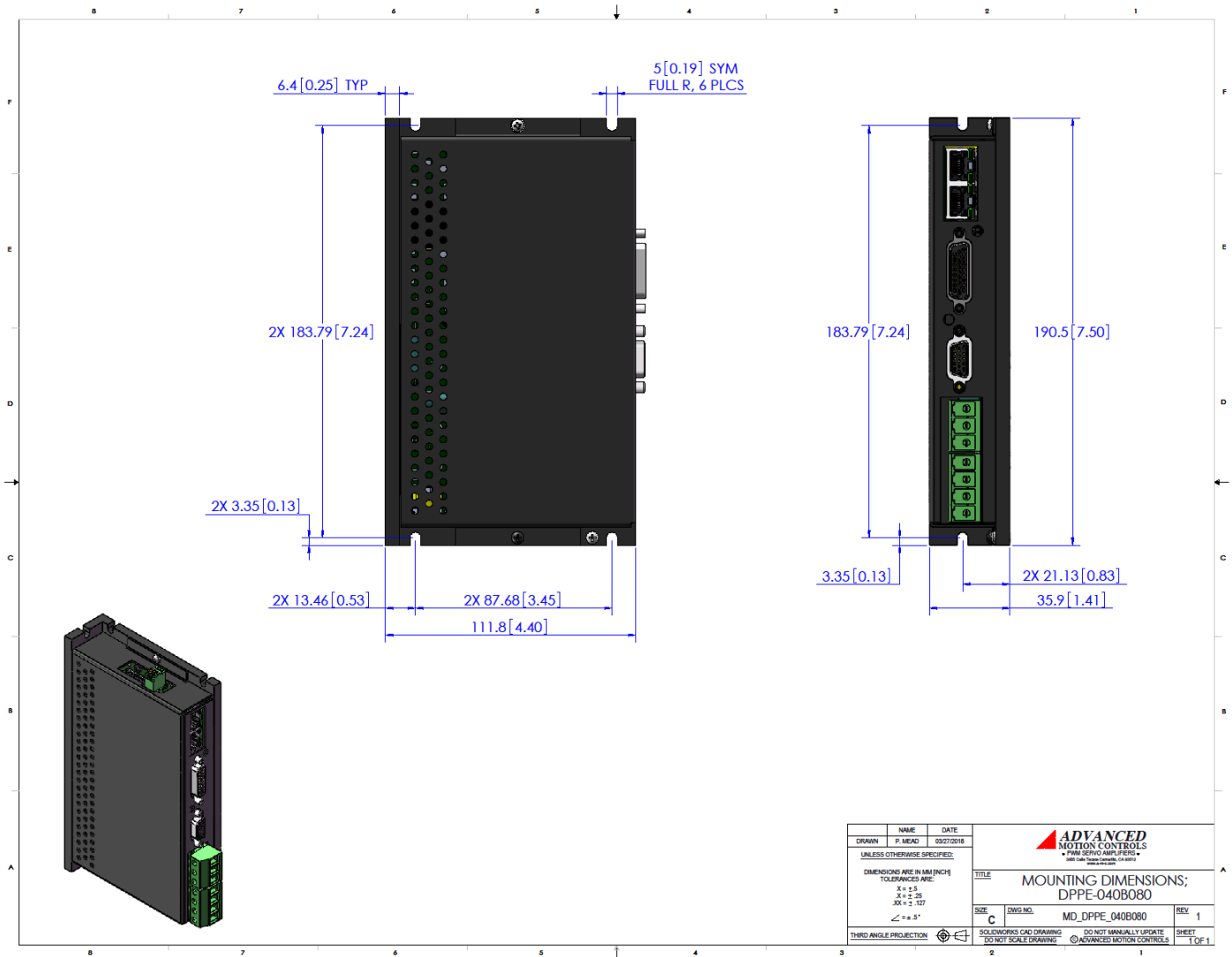

**PART NUMBERING INFORMATION**

Example: **D P C A N T R - 0 6 0 B 0 8 0 -**

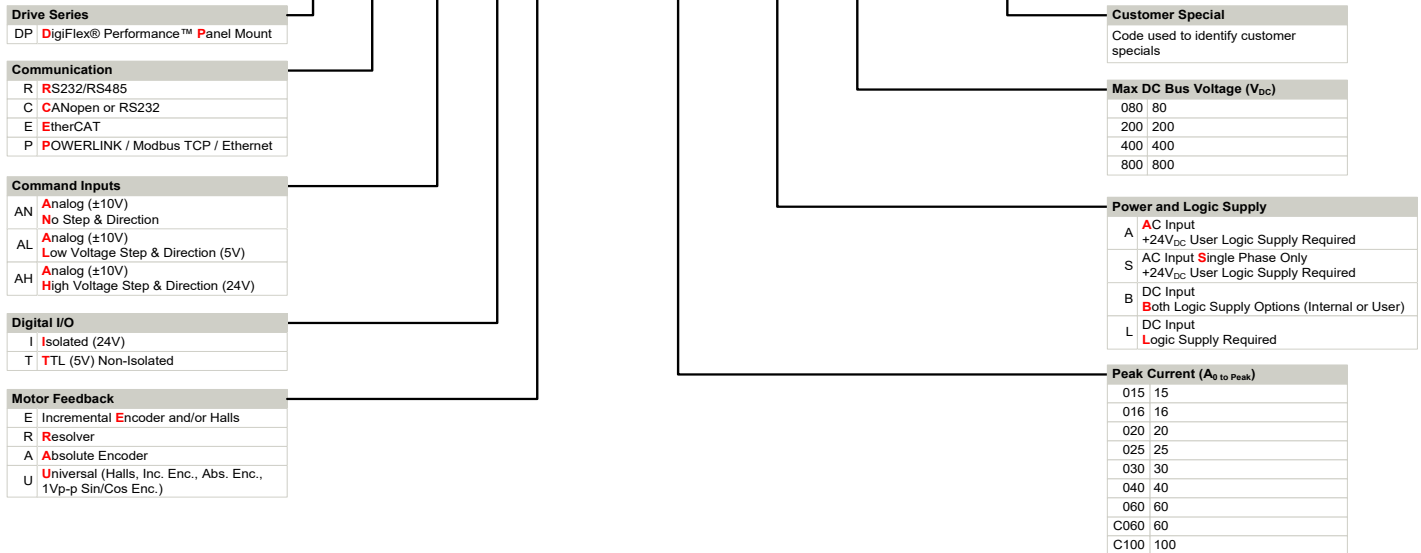

DigiFlex® Performance™ series of products are available in many configurations. Note that not all possible part number combinations are offered as standard drives. All models listed in the selection tables of the website are readily available, standard product offerings.

ADVANCED Motion Controls also has the capability to promptly develop and deliver specified products for OEMs with volume requests. Our Applications and Engineering Departments will work closely with your design team through all stages of development in order to provide the best servo drive solution for your system. Equipped with on-site manufacturing for quick-turn customs capabilities, ADVANCED Motion Controls utilizes our years of engineering and manufacturing expertise to decrease your costs and time-to-market while increasing system quality and reliability. Feel free to contact Applications Engineering for further information and details.

**Examples of Customized Products**

- ▲ Optimized Footprint
- ▲ Private Label Software
- ▲ OEM Specified Connectors
- ▲ No Outer Case
- ▲ Increased Current Resolution
- ▲ Increased Temperature Range
- ▲ Custom Control Interface
- ▲ Integrated System I/O
- ▲ Tailored Project File
- ▲ Silkscreen Branding
- ▲ Optimized Base Plate
- ▲ Increased Current Limits
- ▲ Increased Voltage Range
- ▲ Conformal Coating
- ▲ Multi-Axis Configurations
- ▲ Reduced Profile Size and Weight

**Available Accessories**

ADVANCED Motion Controls offers a variety of accessories designed to facilitate drive integration into a servo system. Visit [www.a-m-c.com](http://www.a-m-c.com) to see which accessories will assist with your application design and implementation.



All specifications in this document are subject to change without written notice. Actual product may differ from pictures provided in this document.