

Description

The BD15A8 PWM servo drive is designed to drive brushless DC motors at a high switching frequency. It is fully protected against over-voltage, over-current, over-heating and short-circuits. The drive interfaces with digital controllers that have a digital PWM output. PWM IN determines the output duty cycle. DIR IN determines the direction of rotation. A single red/green LED indicates operating status. The current limit can be set by DIP switches.

See Part Numbering Information on last page of datasheet for additional ordering options.

Power Range

Peak Current	15 A
Continuous Current	7.5 A
Supply Voltage	20 - 80 VDC



Features

- ▲ Four Quadrant Regenerative Operation
- ▲ Digitally Isolated Digital Inputs
- ▲ Adjustable Current Limits
- ▲ High Switching Frequency
- ▲ Digital Fault Output Monitor
- ▲ Selectable 120/60 Hall Commutation Phasing
- ▲ Drive Status LED

MODES OF OPERATION

- Direct PWM

COMMAND SOURCE

- PWM and Direction

FEEDBACK SUPPORTED

- Halls



COMPLIANCES & AGENCY APPROVALS

- UL
- cUL
- CE Class A (LVD)
- CE Class A (EMC)
- RoHS

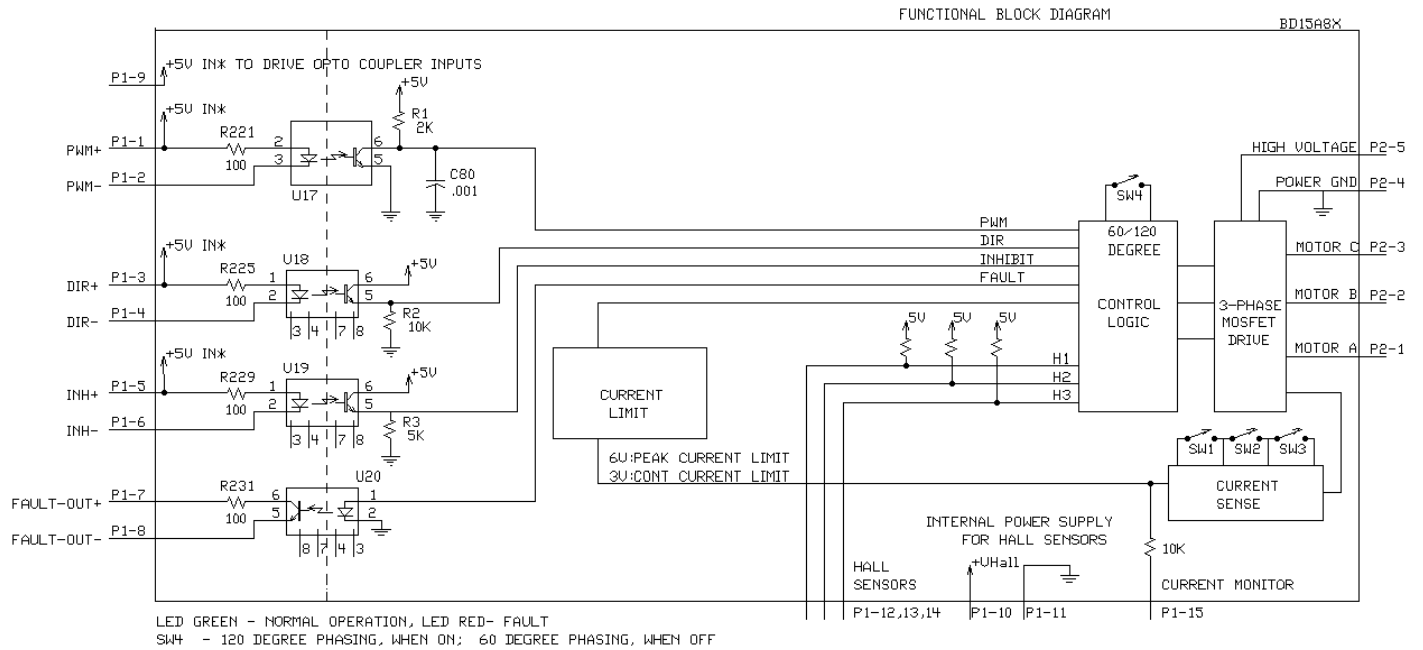
BLOCK DIAGRAM



Information on Approvals and Compliances

	<p>US and Canadian safety compliance with UL 508c, the industrial standard for power conversion electronics. UL registered under file number E140173. Note that machine components compliant with UL are considered UL registered as opposed to UL listed as would be the case for commercial products.</p>
	<p>Compliant with European CE for both the Class A EMC Directive 2004/108/EC on Electromagnetic Compatibility (specifically EN 61000-6-4:2007 and EN 61000-6-2:2005) and LVD requirements of directive 2006/95/EC (specifically EN 60204-1:2006), a low voltage directive to protect users from electrical shock.</p>
	<p>RoHS (Reduction of Hazardous Substances) is intended to prevent hazardous substances such as lead from being manufactured in electrical and electronic equipment.</p>

SPECIFICATIONS

Power Specifications		
Description	Units	Value
DC Supply Voltage Range	VDC	20 - 80
DC Bus Over Voltage Limit	VDC	85
Maximum Peak Output Current ¹	A	15
Maximum Continuous Output Current	A	7.5
Maximum Continuous Output Power	W	570
Maximum Power Dissipation at Continuous Current	W	30
Minimum Load Inductance (Line-To-Line) ²	μH	200
Low Voltage Supply Outputs	-	±6 VDC (3 mA)
Switching Frequency Range	kHz	5 - 20
Control Specifications		
Description	Units	Value
Command Sources	-	PWM and Direction
Feedback Supported	-	Halls
Commutation Methods	-	Trapezoidal
Modes of Operation	-	Direct PWM
Motors Supported	-	Single Phase (Brushed, Voice Coil, Inductive Load), Three Phase (Brushless)
Hardware Protection	-	Invalid Commutation Feedback, Over Current, Over Temperature, Over Voltage, Short Circuit (Phase-Phase & Phase-Ground)
Primary I/O Logic Level	-	5V TTL
Mechanical Specifications		
Description	Units	Value
Agency Approvals	-	CE Class A (EMC), CE Class A (LVD), cUL, RoHS, UL
Size (H x W x D)	mm (in)	129.3 x 75.8 x 25.1 (5.1 x 3 x 1)
Weight	g (oz)	280 (9.9)
Heatsink (Base) Temperature Range ³	°C (°F)	0 - 65 (32 - 149)
Storage Temperature Range	°C (°F)	-40 - 85 (-40 - 185)
Form Factor	-	Panel Mount
P1 Connector	-	16-pin, 2.54 mm spaced, friction lock header
P2 Connector	-	5-port, 5.08 mm spaced, screw terminal

Notes

1. Maximum duration of peak current is ~2 seconds. Peak RMS value must not exceed continuous current rating of the drive.
2. Lower inductance is acceptable for bus voltages well below maximum. Use external inductance to meet requirements.
3. Additional cooling and/or heatsink may be required to achieve rated performance.

PIN FUNCTIONS

P1 - Signal Connector			
Pin	Name	Description / Notes	I/O
1	+PWM	Opto-isolated Pulse Width Modulation Input. Positive input internally connected to P1-9.	I
2	-PWM	Ground negative input to activate. Activating opto-couple activates bridge output.	I
3	+DIR	Opto-isolated Direction Input. Positive input internally connected to P1-9. Ground negative input to activate. Activating opto-couple activates bridge output.	I
4	-DIR		I
5	+INHIBIT	Opto-isolated Inhibit Input. Positive input internally connected to P1-9. Ground negative input to activate. Activating opto-couple activates bridge output.	I
6	-INHIBIT		I
7	+FAULT	Opto-isolated Fault Output (+5 V). Output transistor turns on during output short circuit, over voltage, over temperature, inhibit, invalid Hall state, and during power-up reset. Fault condition indicated by red LED.	O
8	-FAULT		O
9	+5V IN	+5 V (at least 150 mA) input to drive opto-isolated inputs.	I
10	+V HALL OUT		O
11	GND	Low Power Supply For Hall Sensors (+6 V @ 30 mA). Short circuit protected.	GND
12	HALL 1		I
13	HALL 2	Single-ended Hall/Commutation Sensor Inputs (+5 V logic level)	I
14	HALL 3		I
15	CURR MONITOR OUT	Current Monitor. Analog output signal proportional to the actual current output. Scaling is 2 A/V by default but may be reduced by DIP switch settings (see Hardware Settings section below). Measure relative to power ground.	O
16	NC	Not Connected (Reserved)	-

P2 - Power Connector			
Pin	Name	Description / Notes	I/O
1	MOTOR A	Motor Phase A	O
2	MOTOR B	Motor Phase B	O
3	MOTOR C	Motor Phase C	O
4	POWER GND	Power Ground (Isolated From Signal Ground)	PGND
5	HIGH VOLTAGE	DC Power Input	I

HARDWARE SETTINGS

Switch Functions

Switch	Description	Setting	
		On	Off
1	Bit 0 of the current limit setting. See details below.	1	0
2	Bit 1 of the current limit setting. See details below.	1	0
3	Bit 2 of the current limit setting. See details below.	1	0
4	60/120 degree commutation phasing setting	120 degrees	60 degrees

Additional Details

Switches 1, 2 and 3 can be used to reduce the peak and continuous current limit to a percentage given in the table below. 100% means no reduction.

Current Limit %	Current Monitor Scaling (A/V)	Switch Setting		
		Switch 3	Switch 2	Switch 1
12.5	0.25	OFF	OFF	OFF
25	0.5	OFF	OFF	ON
50	1	OFF	ON	ON
100	2	ON	ON	ON

MECHANICAL INFORMATION

P1 - Signal Connector

Connector Information		16-pin, 2.54 mm spaced, friction lock header
Mating Connector	Details	Molex: P/N 22-01-3167 (connector) and P/N 08-50-0114 (insert terminals)
	Included with Drive	Yes

P2 - Power Connector

Connector Information		5-port, 5.08 mm spaced, screw terminal
Mating Connector	Details	Not applicable
	Included with Drive	Not applicable

MOUNTING DIMENSIONS

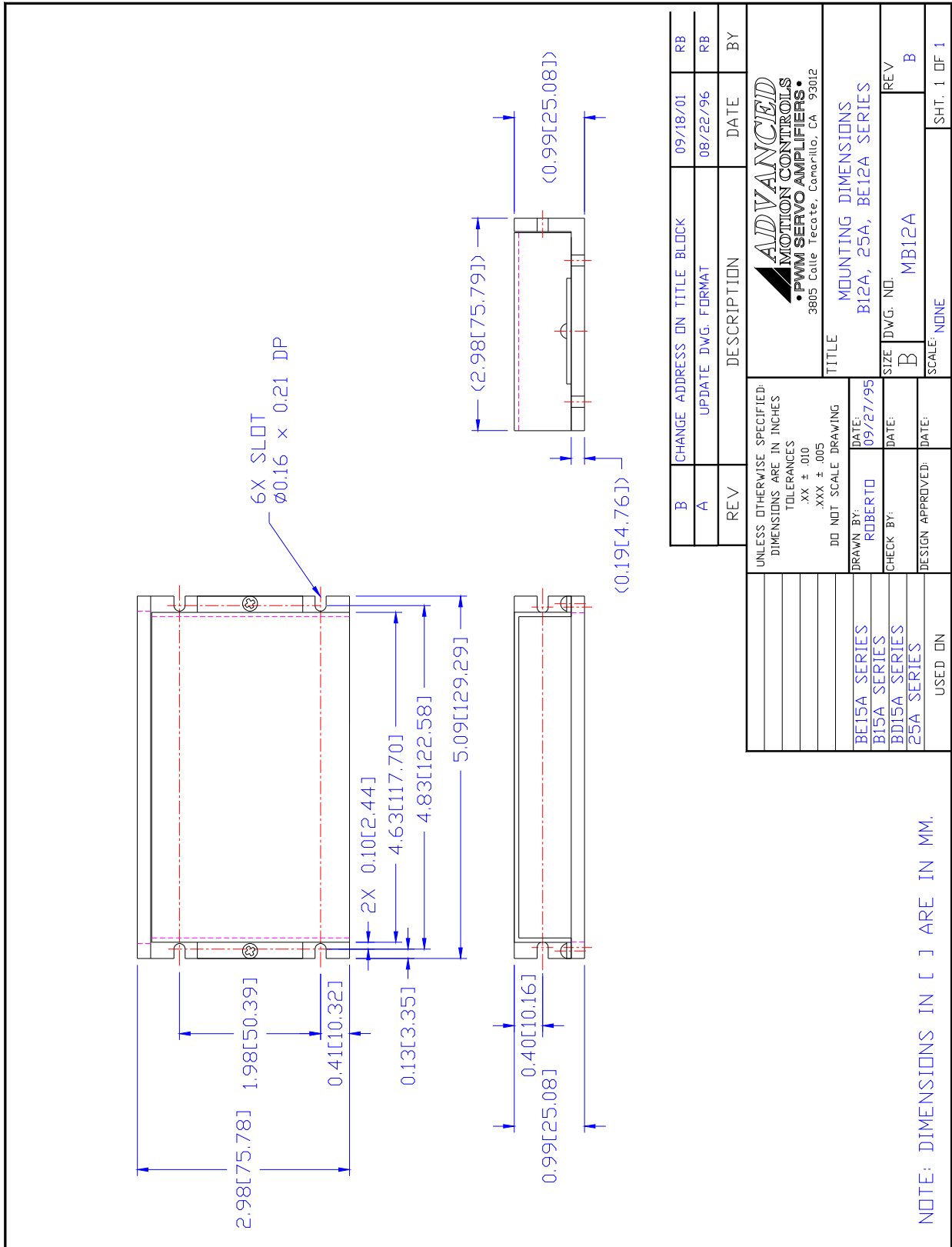

NOTE: DIMENSIONS IN [] ARE IN MM.

PART NUMBERING INFORMATION

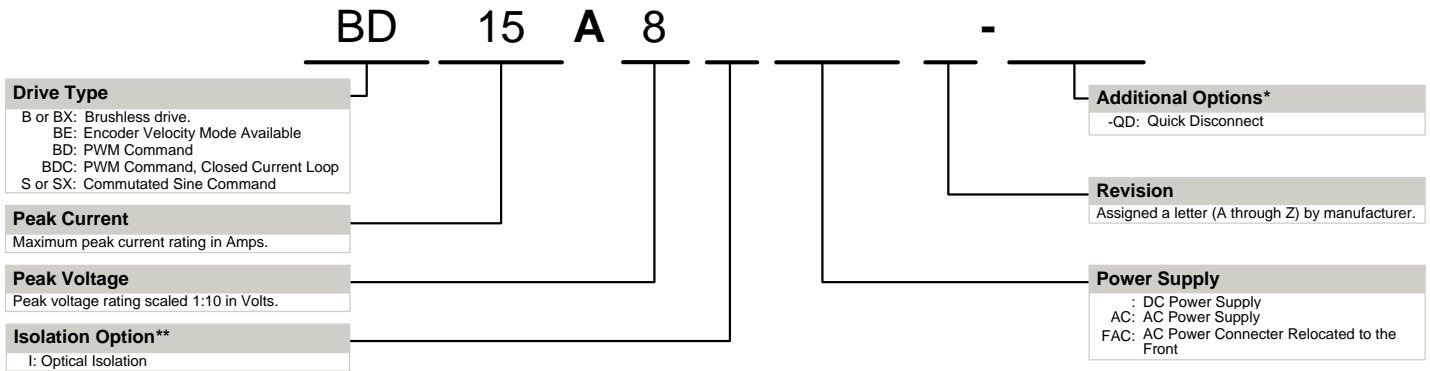

* Options available for orders with sufficient volume. Contact *ADVANCED* Motion Controls for more information.
 ** Isolation comes standard on all AC supply drives and most DC supply drives 200V and above. Consult selection tables of the website or drive datasheet block diagram to see if isolation is included.

ADVANCED Motion Controls analog series of servo drives are available in many configurations. Note that not all possible part number combinations are offered as standard drives. All models listed in the selection tables of the website are readily available, standard product offerings.

ADVANCED Motion Controls also has the capability to promptly develop and deliver specified products for OEMs with volume requests. Our Applications and Engineering Departments will work closely with your design team through all stages of development in order to provide the best servo drive solution for your system. Equipped with on-site manufacturing for quick-turn customs capabilities, *ADVANCED* Motion Controls utilizes our years of engineering and manufacturing expertise to decrease your costs and time-to-market while increasing system quality and reliability.

Examples of Modifications and Customized Products

- | | |
|-----------------------------------------------------------------------------------------------------------------------------------------------------------------------------------------------------------------------------------------------------------------------------------------------------------------------------------------------------------------------------------------------------------------------------------------------------------------------------------------------------------|------------------------------------------------------------------------------------------------------------------------------------------------------------------------------------------------------------------------------------------------------------------------------------------------------------------------------------------------------------------------------------------------------------------------------------------------------------------------------------------------|
| <ul style="list-style-type: none"> ▲ Integration of Drive into Motor Housing ▲ Mount OEM PCB onto Drive Without Cables ▲ Multi-axis Configuration for Compact System ▲ Custom PCB and Baseplate for Optimized Footprint ▲ RTV/Epoxy Components for High Vibration ▲ OEM Specified Connectors for Instant Compatibility ▲ OEM Specified Silkscreen for Custom Appearance ▲ Increased Thermal Limits for High Temp. Operation | <ul style="list-style-type: none"> ▲ Integrate OEM Circuitry onto Drive PCB ▲ Custom Control Loop Tuned to Motor Characteristics ▲ Custom I/O Interface for System Compatibility ▲ Preset Switches and Pots to Reduce User Setup ▲ Optimized Switching Frequency ▲ Ramped Velocity Command for Smooth Acceleration ▲ Remove Unused Features to Reduce OEM Cost ▲ Application Specific Current and Voltage Limits |
|-----------------------------------------------------------------------------------------------------------------------------------------------------------------------------------------------------------------------------------------------------------------------------------------------------------------------------------------------------------------------------------------------------------------------------------------------------------------------------------------------------------|------------------------------------------------------------------------------------------------------------------------------------------------------------------------------------------------------------------------------------------------------------------------------------------------------------------------------------------------------------------------------------------------------------------------------------------------------------------------------------------------|

Feel free to contact Applications Engineering for further information and details.

Available Accessories

ADVANCED Motion Controls offers a variety of accessories designed to facilitate drive integration into a servo system. Visit www.a-m-c.com to see which accessories will assist with your application design and implementation.

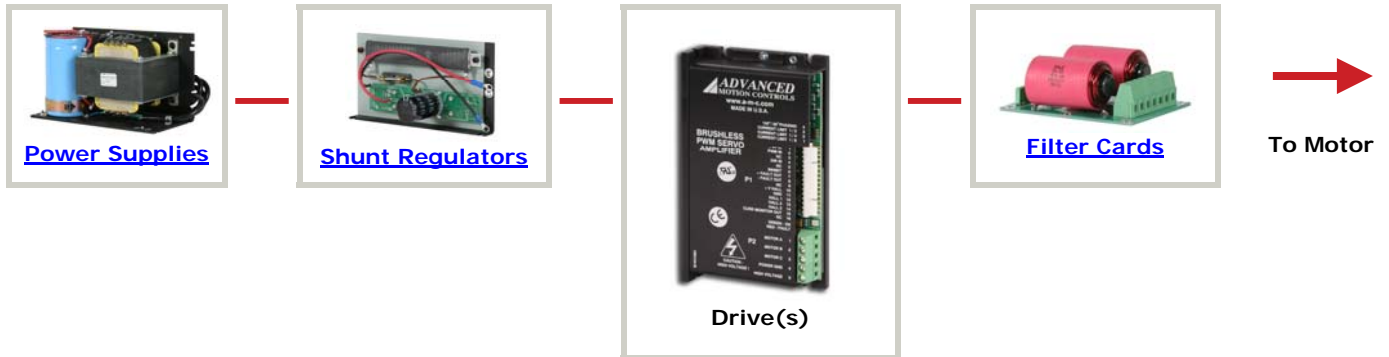

All specifications in this document are subject to change without written notice. Actual product may differ from pictures provided in this document.